

**OUTDOOR
REVOLUTION**



WWW.OUTDOOR-REVOLUTION.COM

...Bringing the outdoors to everyone



2023 Collection - Caravan & Motorhome Awnings



OUTDOOR **REVOLUTION**

WWW.OUTDOOR-REVOLUTION.COM



At Outdoor Revolution we are committed in our mission to creating the most desirable market leading products; utilising pioneering technology along with the most technical performance fabrics, across our superbly practical ranges of caravan awnings, driveaway awnings, family tents and accessories; to ultimately maximise your enjoyment of the camping experience.

In the nonstop world we live in, leisure time has become increasingly important for everyone. Outdoor Revolution strive to facilitate this precious family time by creating the most reliable, practical and most competitively priced products on the market, together with our endless vision for innovation, quality and value.



...Bringing the outdoors to everyone



Contents

6-9
Eden
Caravan
Awnings

12-15
Sportlite
Caravan &
Motorhome
Awnings

18-21
Eclipse Pro
Caravan &
Motorhome
Awnings

24-29
Esprit Pro X
Caravan &
Motorhome
Driveaway
Awnings

Accessories
10, 11 - Campese Inflatable Furniture
16, 17 - Lighting
22, 23 - Furniture
30, 31 - Windbreaks
32, 33 - Caravan Accessories
34, 35 - Sleeping

CARAVAN AWNINGS



AIR FRAME SYSTEMS EXPLAINED...



Outdoor Revolution have pioneered the Oxygen Air Frame System; the quickest, easiest and most reliable air frame and inflation system on the market today. A system unique to Outdoor Revolution and envied by other manufacturers of air awnings, driveaways & air tents.

Featured in the Sportlite & premium Eclipse Pro ranges, the unique pressure relief valve (IF - Intelligent Frame) is designed to regulate and control the air pressure inside the air tube and acts as a safety mechanism to prevent burst air tubes through over inflation or excessive air expansion on hot days.

Whilst factory tested up to 19PSI, we recommend the Oxygen Air Frame is inflated to a working pressure of approximately 6PSI, which is around the max pressure to which our relief valve is factory set at before it starts to release excess air pressure. Depending on ambient temperature changes, the PSI can increase dramatically on warm sunny days as the air inside the tube will expand.

If the PSI pressure increases to over the recommended 6 PSI (through either over inflation or changes in ambient temperature) the Intelligent Frame Relief Valve will expel the surplus air and maintain the air pressure within the air frame at a safe level. This unique system ensures that the tubes cannot be stressed and damaged by increasing pressures.

Because we are so confident in our air frame, we offer a *LIFETIME GUARANTEE on all air frame models which incorporate our unique IF - DSV inflation system.*Terms and conditions apply



New for 2023 & incorporated into the all new Esprit Pro X awning range, the Outdoor Revolution 'Air Lock off Valve System' offers unrivalled functionality & peace of mind in your premium awning oxygen air frame.

This new ground breaking system for Outdoor Revolution offers the ability to connect each individual air tube in the air frame via connective air hoses in which each hose incorporates an air lock off valve, enabling air to pass freely between each individual tube of the entire frame to create a single inflation air frame for ease & speed of inflation. Once the frame is inflated, the valves can be locked off to isolate each individual air tube & preventing the complete awning deflating should any air tube be damaged resulting in air loss. Individual tubes can then be quickly and easily disconnected & individually replaced in such emergencies, thus enabling the awning to still function & operate as normal whilst a new tube is fitted. This system offers the end user complete peace of mind in the event of an air tube failure as in most cases the awning can still be used as normal. This system comes complete with an extended 3 years manufacturers warranty, covering tube replacement in the vent of a tube failure. Terms & conditions apply.

Deflating the Oxygen Air Frame is simple with our easy to operate DSV valve (Dynamic Speed Valve). With just a simple push of a button, the valve will expel all the air from the frame, which will deflate and come down in seconds. No messing around with unscrewing difficult to get hold of leaky, slippery and unreliable valve caps.

Technology & Innovation...

No longer just a caravan awning; today's modern Outdoor Revolution awnings represent the most advanced developments in awning technology and the very finest standards in British design and innovation. Outdoor Revolution are proud to be the industry innovators of inflatable awnings, to which our aim is to always listen to our customers needs when designing new products. Our 20232 range provides a broad and diverse awning collection with all models being fitted with our 4mm & 6mm Twin Piping System (TPS) for dual compatibility between caravans and motorhomes. A truly comprehensive range designed with something to suit everyone.

Our choice of technically advanced awning fabrics are specifically designed and selected for their specific qualities in durability, UV and fade resistance, weather proofing and with a high strength to weight ratio. Every awning design is fully weather tested in our purpose built rain house, simulating heavy rainfall comparable to a tropical storm. All our air tubes are pressure tested individually for a minimum of 72 hours before being installed into our awnings. Our inflation (DSV) and pressure relief (IF) valves, fitted on selected models, are individually tested to precise high pressure tolerances in laboratory conditions before being installed into air tubes. Backed up with our air tube Lifetime Guarantee (IF + DSV models), together with new innovations such as the Esprit X connective valve system, make your choice to buy an Outdoor Revolution awning a true leisure time investment.

Quality & Choice In Fabrics...

Eclipse Pro & Esprit Pro X ranges - Pro 600HD - (6000mm Hydrostatic Head)

Updated 600HD high-density Oxford weave fabric provides the look and feel of a traditional awning, whilst remaining lightweight. This fabric balances the usability of man made fibres and the tactility of natural materials to create a technical, high performing fabric. This doesn't only create a sense of luxury, it provides vital weight and space saving benefits.

Eden Air range - 120HDE - (3000mm Hydrostatic Head)

This lightweight fabric has been specifically designed to deliver lightweight, compact products whilst maintaining strength and durability. Woven using the latest textile manufacturing techniques, this fabric is designed for performance with a high weight to strength ratio.

Sportlite Air range - 280HDE - (4000mm Hydrostatic Head)

This robust lightweight fabric has been specifically designed to deliver strength in lightweight products. Woven using the latest textile manufacturing techniques, this fabric is designed for longevity and performance.

EDEN AIR AWNINGS - just the essential features without any fuss

**'LIGHTWEIGHT AFFORDABLE
CARAVAN AWNINGS
WITHOUT THE FUSS'**

OXYGEN
AIR FRAME

The Eden Air awning range is a lightweight no fuss value awning range of 2 models covering 260 & 390 popular width options.

Designed to keep weight and speed of pitching down to a minimum, these affordable air frame awnings are the perfect partner for short weekend breaks or holidays on a budget.

Constructed from 120HDE Hex fabric, a technical lightweight weatherproof fabric with a high strength to weight ratio; always a bonus when keeping weight down is a pre requisite, especially when lifting & attaching to the caravan rail.

Featuring individually inflated air poles with boston style inflation valves, lightweight fibreglass roof tension poles, zip back doors and handy hanging points for an optional 2 berth clip in inner tent; the Eden range offers just the essential features that you need.

...without any of the fuss





EDEN 260

'Lightweight affordable air awning with just the essential features'

The **Eden 260** is a value, affordable inflatable porch style awning designed with low weight, simplicity and practicality in mind. Available in connection heights to suit all caravans from 235cm - 250cm. Each tube is inflated individually by separate reliable boston style valves. The robust yet lightweight nature of the 120HDE polyester fabric makes it extremely manageable to pack and transport. Offering a generous living space with the option to clip in a 2 berth sleeping inner tent into the main living area. Weighing in at 13kg, the Eden 260 represents great value for money and the ideal short stay compact, lightweight caravan awning.

Key Features

- 120HD high density all weather lightweight fabric
- Hydrostatic head 3000mm
- Reliable and simple to use boston style valve system
- Front left & right zip back doors
- Zip back left and right side doors
- Clip points for optional 2 berth inner tent
- Zip up blind style curtain system
- Diamond clear PVC windows
- Colour coded guylines
- Adjustable webbing pegging system
- Includes pump, draught skirt, peg set, carry bag

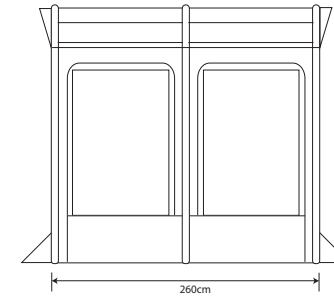
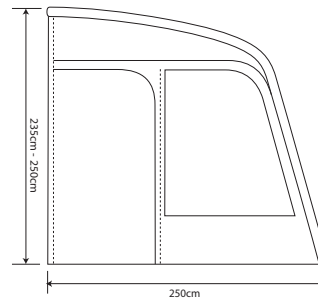

OXYGEN
AIR FRAME

Eden 260
Height Range 235cm - 250cm

Total Weight 13kg
Pack Size 78x32x32
Footprint 250 x 320cm

EDEN 390

'Lightweight affordable air awning with just the essential features'

The **Eden 390** is a value affordable inflatable porch style awning designed with low weight, simplicity and practicality in mind. Available in connection heights to suit all caravans from 235cm - 250cm. Each tube is inflated individually by separate reliable boston style valves. The robust yet lightweight nature of the 120HDE polyester fabric with a high strength to weight ratio making it extremely manageable to pack and transport. Offering a generous living space with the option to clip in a 2 berth sleeping inner tent into the main living area provides great versatility. Weighing in at under 16kg, the Eden 390 represents great value for money and the ideal short stay lightweight caravan awning.



Key Features

- 120HD high density all weather lightweight fabric
- Hydrostatic head 3000mm
- Reliable and simple to use boston style valve system
- Front left & right zip back doors
- Zip back left and right side doors
- Clip points for optional 2 berth inner tent
- Zip up blind style curtain system
- Diamond clear PVC windows
- Colour coded guylines
- Adjustable webbing pegging system
- Includes pump, draught skirt, peg set, carry bag

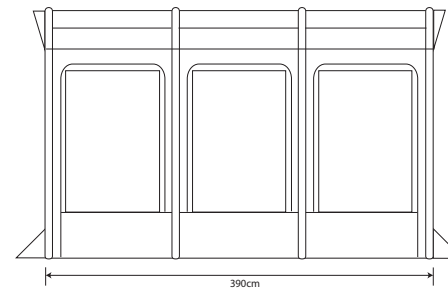
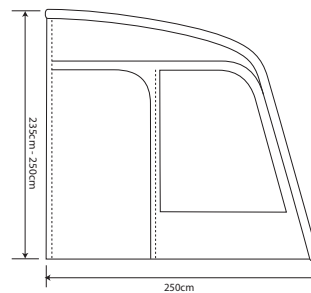

OXYGEN
AIR FRAME

Eden 390

Height Range 235cm - 250cm

Total Weight 16kg
Pack Size 80x40x33
Footprint 250 x 390cm



Treadlite Carpet by Outdoor Revolution is the ultimate lightweight breathable outdoor carpet for your caravan awning. Featuring an open weave that allows air and moisture through, enabling the grass beneath to breathe, therefore preventing it from yellowing. Treadlite is suitable for any pitch and is perfect for camp sites that insist on having a mandatory breathable groundsheet.

During use Treadlite is secured in place by pegging the corners and intermediate eyelets to prevent movement. After use the carpet packs compactly away into its own carry bag for ease of transportation and storage. Being completely rot and water proof, Treadlite carpet is extremely durable and simple to clean and maintain by hosing down or power washing after use.

Manufactured in a diverse range of made to measure size options, each of which has been tailored to fit our latest and previous popular models of caravan awnings, including popular generic sizes compatible with other awning brands. Please refer to the technical specifications to view all current available sizes.

MAIN FEATURES

- Available in a full range of popular sizes
- Rot proof, washable, flame retardant & UV resistant
- Allows grass to breath
- Stops insects coming through
- None-slip and easy to clean, close weave.
- Fully hemmed with large eyelets for pegging
- Recommended and allowed on all camp sites



CODE	SIZE / DESCRIPTION	BARCODE
ORBK8895	Ozone 6.0 XTR Safari / Kalahari PC 7.0 Patio Groundsheet (550 x 200)	5060542053600
ORFT3029	Ozone 8.0 Safari Lodge Patio Groundsheet (700 x 200)	5060542054522
TRE260B	Esprit Pro X Extension 260cm x 230cm Treadlite - Grey	5060542053570
TRE260	260cm x 250cm Treadlite - Grey	5060542057592
TRE390	390cm x 250cm Treadlite - Grey	5060542057554
TRE1005	Sportlite Air 320 320cm x 250cm Treadlite - Grey	5060542055413
TRE250B	250cm x 250cm Treadlite - Grey	5060542050128
TRE300B	300cm x 250cm Treadlite - Grey	5060542050135
TRE325B	325cm x 240cm Treadlite - Grey	5060542053587
TRE330	330cm x 250cm Treadlite - Grey	5060542057585
TRE350B	350cm x 250cm Treadlite - Grey	5060542050142
TRE380	380cm x 250cm Treadlite - Grey	5060542057561
TRE400B	Sportlite 400 400cm x 250cm Treadlite - Grey	5060542050159
TRE3450	400cm x 300cm Treadlite - Grey	5060105562754
TRE420	420cm x 250cm Treadlite - Grey	5060542057578
TRE450B	450cm x 250cm Treadlite - Grey	5060542050166
TRE500B	500cm x 250cm Treadlite - Grey	5060542050180
TRE550B	550cm x 250cm Treadlite - Grey	5060542050197
TRE600B	600cm x 250cm Treadlite - Grey	5060542050173
TRE650B	650cm x 250cm Treadlite - Grey	5060542050203
TRE700B	700cm x 250cm Treadlite - Grey	5060542050210
TRE750B	750cm x 250cm Treadlite - Grey	5060542050227

'CAMPESE' & 'CAMPESE THERMO' PREMIUM INFLATABLE FURNITURE



'PREMIUM INFLATABLE CAMPING FURNITURE WITH ADDED WARMTH & COMFORT'

In addition to the best selling 'CAMPESE' inflatable furniture range; 'CAMPESE THERMO' by Outdoor Revolution sets the bar even higher when it comes to added warmth, luxury, comfort, support and style. Comprising of a 2 seat sofa, arm chair & foot stool.

At the heart of this award winning super soft & cosy inflatable furniture range is the all new thermo foam lined luxury fabric in blue grey mottle (another first for Outdoor Revolution) with stylish stitched quilted panels on the seat, arms & chair backs; creating the cosiest & most comfortable inflatable camping furniture range yet. The all new design chair back and side arm shape offers increased support and stability for better seated posture, whilst the exterior foam padded chair cover gives the furniture its strength & rigidity, just like your regular living room furniture. With added side pockets to conveniently store and tidy away your magazines, books or digital tablets; the Campese Thermo furniture does it all when it comes to relaxing in comfort whilst camping outdoors.

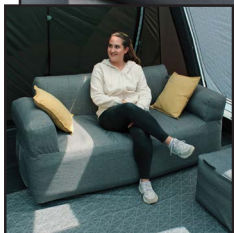

GREY/BLUE FABRIC WITH THERMAL COMFORT LAYER

FOR DETAILS OF THE FULL RANGE OF 2023 OUTDOOR REVOLUTION CAMPESE INFLATABLE FURNITURE CHECK OUT: WWW.OUTDOOR-REVOLUTION.COM



Camping
MAGAZINE

Editor's Choice
awards
2022

COMMENDED
BEST TENT FURNITURE



OUTDOOR
REVOLUTION

WWW.OUTDOOR-REVOLUTION.COM

...Bringing the outdoors to everyone

SPORTLITE AIR AWNINGS - the faster, lighter awning option

'DISCOVER A RANGE OF LIGHTER CARAVAN & MOTORHOME AWNINGS'

OXYGEN
AIR FRAME

The Sportlite Air awning range for 2023 comprises of three distinct lightweight caravan awning models plus a tall motorhome option.

Each model is tailored and constructed from our tried and tested 280HDE polyester, a technical robust fabric with a high strength to weight ratio, always a bonus when keeping weight down is a pre requisite, especially when attaching the tall 320L motorhome version to wind out awning rails where weight can be an issue.

The Sportlite Air 320EX features an integral tall extension which can be used for extra living, storage, dining space or with the addition of a clip in 2 berth inner tent, can be used as a partitioned off private bedroom area. The perfect solution for maximising awning space on shorter caravans.

Sportlite awning models come with zip out side doors with Phoenix mesh panels to take the Sportlite annexe with sleeping inner tent on either left or right hand side (320EX to the right hand side only).

A fully welded Dura-Tech air frame enables super fast single point inflation, protected by the Outdoor Revolution signature pressure relief valve.

...Go Light - Go Sportlite!





SPORTLITE AIR 320 / L

'Lightweight air awning available in caravan & motorhome heights'

The **Sportlite Air 320** is a high-performance inflatable Porch Awning designed with functionality and practicality in mind. Available in 2 connection heights to suit all caravans and motorhomes up to 265cm height. Inflated from a single point, this lightweight awning goes up and down in minutes. The robust yet lightweight nature of the 280HDE polyester fabric makes it extremely manageable to pack and transport. Offering generous living space with the option to zip an annexe onto either side, this awning is packed full of features, including mesh fly-screen panels, zip-up curtains throughout and two fully roll back front doors.

Key Features

- 280HDE high density all-weather lightweight fabric
- Hydrostatic head 4,000mm
- Single inflation point Dura-tech fully welded air frame
- LIFETIME GUARANTEE on the Air Frame System (T's & C's apply)
- Dynamic Speed & Intelligent Frame relief valve system
- Front left and right zip across doors
- Zip-out left and right side doors with zip-back Phoenix mesh panels
- Zip-on annexe with inner option to fit both left and right hand sides (200 x 225cm)
- Zip-up blind style curtain system
- Diamond clear PVC windows
- Reflective guy lines
- Adjustable webbing pegging system
- Includes pump, draught skirt, peg set, storm straps, and carry bag

Sportlite Air 320



Sportlite Air 320L

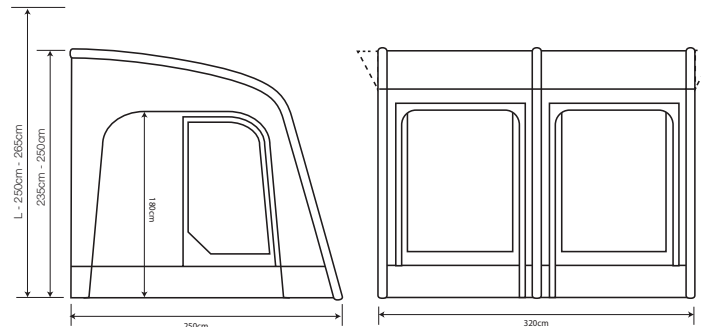

OXYGEN
AIR FRAME

Sportlite Air 320

Height Range 235cm - 250cm

Total Weight 18.27kg
Pack Size 83x50x41
Footprint 250 x 320cm

Sportlite Air 320L

Height Range 250cm - 265cm

Total Weight 19.37kg
Pack Size 83x50x41
Footprint 250 x 320cm

SPORTLITE AIR 400

‘Stylish, lightweight high-performance modern air awning’

The **Sportlite Air 400** is a stylish, lightweight high-performance modern air awning designed by caravanner's, for caravanner's, with functionality and practicality in mind. Inflated from a single point and deflated from 2, this awning goes up and down in minutes making it perfect for touring enthusiasts. The robust yet lightweight nature of the 280HDE polyester fabric makes it extremely manageable to pack and transport. Offering plentiful living space and with the option to zip a bedroom annexe onto either side of the awning. Packed full of features including mesh fly-screen panels on both side doors, zip-up curtains throughout and three fully roll-back front doors. Weighing in at under 22kg the Sportlite Air 400 offers exceptional value for money!



Key Features

- 280HDE high density all-weather lightweight fabric
- Hydrostatic head 4,000mm
- Single inflation point Dura-tech fully welded air frame
- LIFETIME GUARANTEE on the Air Frame System (T's & C's apply)
- Dynamic Speed & Intelligent Frame relief valve system
- Front left and right zip across doors
- Zip-out left and right side doors with zip-back Phoenix mesh panels
- Zip-on annexe with inner option to fit both left and right hand sides (200 x 225cm)
- Zip-up blind style curtain system
- Diamond clear PVC windows
- Reflective guy lines
- Adjustable webbing pegging system
- Includes pump, draught skirt, peg set, storm straps, and carry bag

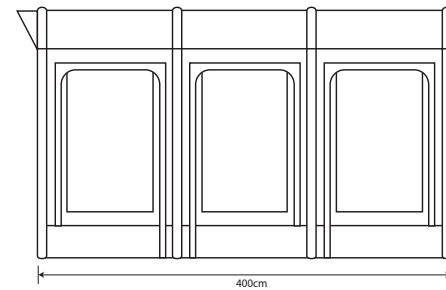
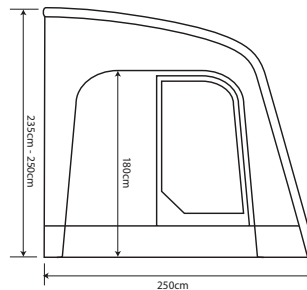
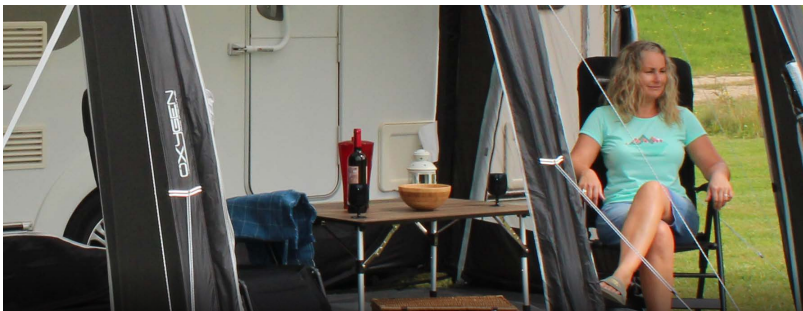

OXYGEN
AIRFRAME

Sportlite Air 400

Height Range 235cm - 250cm

Total Weight 21.67kg
Pack Size 86x45x40
Footprint 250 x 400cm



SPORTLITE AIR 320EX

‘Featuring a multifunctional integral extension’

The **Sportlite Air 320 EX** is based on the popular 320 model, featuring an integral multifunctional extension with internal partitioned divider section, providing increased space and functionality (includes 2 berth inner tent hanging points) for smaller caravans without the restriction imposed by short connection rails. Full zip back doors across the front with the extension door incorporating a full mesh zip back panel, provide multiple access options and the ability to open up the entire awning front. A right hand fully zip off side door with mesh panel enables a further zip on annexe to be attached to create increased sleeping options (sleeping up to 4 people) for larger families.

Key Features

- 280HDE high density all-weather lightweight fabric
- Hydrostatic head 4,000mm
- Single inflation point Dura-tech fully welded air frame
- LIFETIME GUARANTEE on the Air Frame System (T's & C's apply)
- Dynamic Speed & Intelligent Frame relief valve system
- Integral multifunctional extension with divider door & rear locker box access door
- Front left and right zip across doors
- Zip-out right side door with zip-back Phoenix mesh panel
- Zip-on annexe option with inner to fit right hand side only (200 x 225cm)
- Diamond clear PVC windows with Zip-up blind style curtain system
- Reflective guy lines
- Adjustable webbing pegging system
- Includes pump, draught skirt, peg set, storm straps, and carry bag



Shown with Sportlite annexe option

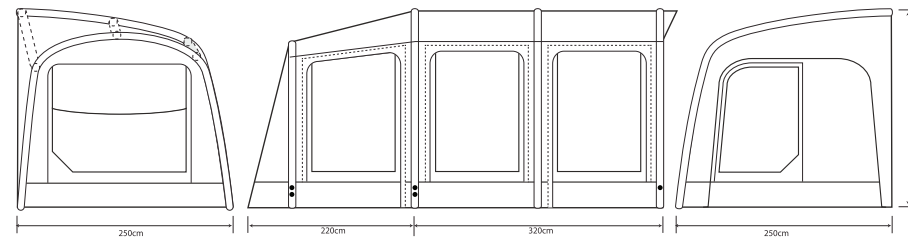

OXYGEN
AIR FRAME

Sportlite Air 320EX

Height Range 235cm - 250cm

Total Weight 24.5kg
Pack Size 81x46x38cm
Footprint 250 x 540cm

CAMPING LIGHTING... ILLUMINATED CAMPING INNOVATION

**'A COMPREHENSIVE RANGE
OF INNOVATIVE,
MULTIFUNCTIONAL
HI-TECH CAMPING LIGHTS'**

Outdoor Revolution are proud to boast the some of the most innovative, multifunctional camping lighting & anti mosquito products on the market today. As well as our best selling range of Lumi-Lite products, including our famed Lumi-Link which both perfectly integrate with your Outdoor Revolution awning, driveaway or tent ; we have introduced some exciting new lighting innovations for 2023 season.

New for 2023, Outdoor Revolution introduce a range of premium LED & tungsten lanterns, designed in a traditional style with functions such as dimmable LED flicker flame effects, integrated power bank & bluetooth speaker functions. Designed using premium materials such as steel & bamboo, this classy collection of traditional camping lantern lighting is sure to create a warm & cosy ambiance to your evenings which will perfectly complement your Outdoor Revolution outdoor adventure.

As well as our range of camping lighting, we are proud to continue to lead the industry with our range of multifunctional mosquito & insect exterminating lanterns, keeping the inside of your awning or tent free from any biting insect nasty.

Lantern fans



Solar lanterns



Mosquito lanterns



**FOR DETAILS OF THE FULL RANGE OF 2023 OUTDOOR REVOLUTION CAMPING LIGHTING RANGE CHECK OUT:
WWW.OUTDOOR-REVOLUTION.COM**

LED flicker flame lanterns



LED tube lighting



ECLIPSE PRO AIR AWNINGS - premium caravan & motorhome awnings

**'PREMIUM OPTIONS FOR
BOTH CARAVANS &
MOTORHOMES'**

OXYGEN
AIR FRAME

The Eclipse Pro Air awning collection is a premium range of 3 caravan awnings and 1 motorhome awning model.

Comprising of 3 models in 330, 380 (updated in 2022) & 420 widths plus conservatory annexe, with the addition of a further motorhome height model in the 380 size. Adorned with a myriad of features including the famed Dura-Tech fully welded Oxygen air frame with single point inflation for super fast pitching. As with all our premium awnings which incorporate both our DSV & IF valve, the frame is protected by our signature Intelligent Frame System backed up and complemented by our *Lifetime air tube Guarantee

The Eclipse Pro awning range has plenty of ventilation, with toughened zip back breathable mesh panels built into both side doors, letting in plenty of air whilst keeping out flying bugs. A full zip in mesh accessory door is also available for the central door in the 380 & 420 models as well as both side doors, perfect for warm climates.

Constructed in the luxury 600HD premium awning fabric for durability & complete weather protection, the clean lines of the Eclipse model sets the bar high when it comes to modern cutting edge design.

...designed to eclipse all others





ECLIPSE PRO 330

'Stylish premium single inflation caravan air awning'

The **Eclipse Pro 330** is established as a firm favourite amongst tourers. Based on the popular width of 3.3m it boasts a myriad of high-end features including our famed Dura-Tech fully welded air frame with single point inflation for super-fast pitching. Offering plenty of ventilation through toughened zip-back breathable mesh panels on both side doors, there is an abundance of air flow whilst flying insects are kept out. For extended living space, a fantastic Conservatory Annex can be zipped onto either side to create a large sleeping area, or a usable windowed conservatory, dining or storage space.



Key Features

- Pro 600HD high density all-weather premium fabric
- Hydrostatic head 6,000mm
- Inflatable Dura-tech fully welded tube Oxygen Air Frame system
- LIFETIME GUARANTEE on the Air Frame System (T's & C's apply)
- Dynamic Speed Valve & Intelligent Frame relief valve system
- Front left and right zip-back doors with central zip-out door
- Full walk in (195cm) height side door entrances
- Zip out left and right side doors with zip back Phoenix mesh panels
- Zip-on side annexe option with inner (fits left or right side) (200 x 220cm)
- Tinted anti glare PVC windows with zip-up curtain blinds
- Tinted anti glare PVC roof windows
- Ground Anchor Webbing secure guying system
- Adjustable webbing pegging system
- Includes pump, draught skirt, peg set, storm straps and carry bag



Shown with Eclipse Pro Annexe option

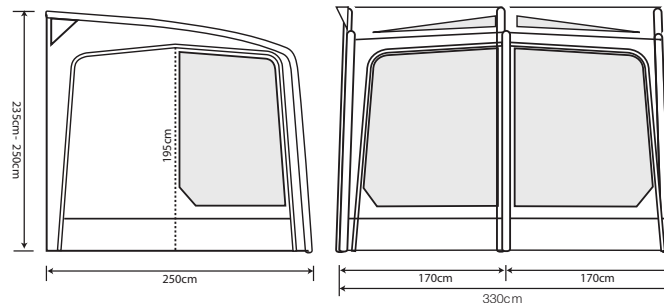

OXYGEN
AIR FRAME

Eclipse Pro 330

Height Range 235cm - 250cm

Total Weight 24.87kg
Pack Size 81x51x43
Footprint 250 x 330cm

ECLIPSE PRO 380 / L

'Available in 2 heights to suit your caravan & motorhome'

Available in 2 heights to suit caravans & motorhomes, the **Eclipse Pro 380** has become a firm favourite amongst caravan tourers & motorhomers alike. With an attractive panoramic design, the Eclipse Pro 380 boasts a myriad of high-end features including our famed Dura-Tech fully welded air frame with single point inflation for super-fast pitching. As with all our premium awnings, the frame is protected by our Intelligent Frame system (IF) which regulates the air pressure and protects from over inflation, for added piece of mind it is backed up by our lifetime air tube guarantee. A full zip in mesh accessory door is also available for the central & both side doors, perfect for warm climates.



Key Features

- Pro 600HD high density all-weather premium fabric
- Hydrostatic head 6,000mm
- Inflatable Dura-tech fully welded tube Oxygen Air Frame system
- LIFETIME GUARANTEE on the Air Frame System (T's & C's apply)
- Dynamic Speed Valve & Intelligent Frame relief valve system
- Front left and right zip-back doors with central zip-out door
- Full walk in (195cm) height side door entrances
- Zip out left and right side doors with zip back Phoenix mesh panels
- Zip-on side annexe option with inner (fits left or right side) (200 x 220cm)
- Tinted anti glare PVC windows with zip-up curtain blinds
- Tinted anti glare PVC roof windows
- Ground Anchor Webbing secure guying system
- Adjustable webbing pegging system
- Includes pump, draught skirt, peg set, storm straps and carry bag



Shown with Eclipse Pro annexe option

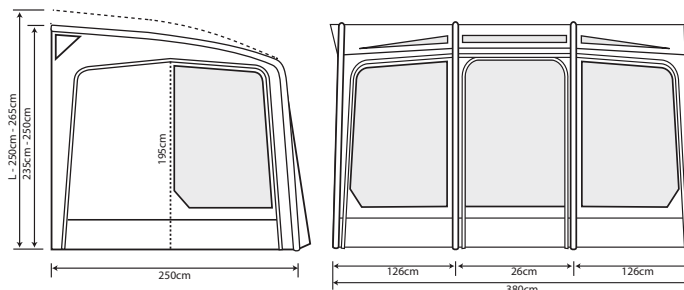

OXYGEN
AIR FRAME

Eclipse Pro 380

Height Range 235cm - 250cm

Total Weight 28.6kg
Pack Size 86x54x46
Footprint 250 x 380cm

Eclipse Pro 380L

Height Range 250cm - 265cm

Total Weight 30.2kg
Pack Size 86x57x48
Footprint 250 x 380cm



ECLIPSE PRO 420

‘Spacious feature packed premium caravan awning’

The all new **Eclipse Pro 420** is set to continue as a firm favourite amongst tourers this season. Based on the popular width of 4.2m the Eclipse Pro 420 boasts a myriad of features including our famed Dura-Tech fully welded air frame with single point inflation for super-fast pitching. As with all our premium awnings, the frame is protected by our Intelligent Frame system (IF) and is backed up by our lifetime air tube guarantee. The Eclipse Pro 420 has plenty of ventilation, with toughened zip back breathable mesh panels built into both side doors, letting in plenty of air whilst keeping out flying bugs. A full zip in mesh accessory door is also available for the central & both side doors, perfect for warm climates.

Key Features

- Pro 600HD high density all-weather premium fabric
- Hydrostatic head 6,000mm
- Inflatable Dura-tech fully welded tube Oxygen Air Frame system
- LIFETIME GUARANTEE on the Air Frame System (T's & C's apply)
- Dynamic Speed Valve & Intelligent Frame relief valve system
- Front left and right zip-back doors with central zip-out door
- Full walk in (195cm) height side door entrances
- Zip out left and right side doors with zip back Phoenix mesh panels
- Zip-on side annexe option with inner (fits left or right side) (200 x 220cm)
- Tinted anti glare PVC windows with zip-up curtain blinds
- Tinted anti glare PVC roof windows
- Ground Anchor Webbing secure guying system
- Adjustable webbing pegging system
- Includes pump, draught skirt, peg set, storm straps and carry bag



Shown with Eclipse Pro annexe option

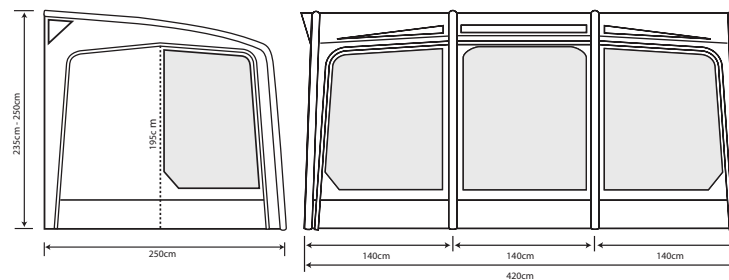

OXYGEN
AIR FRAME

Eclipse Pro 420

Height Range 235cm - 250cm

Total Weight 28.87kg
Pack Size 86x54x47
Footprint 250 x 420cm

CAMPING FURNITURE... CHAIRS, TABLES, UTILITY & STORAGE

'POPULAR BEST SELLING MODELS WITH INNOVATIVE NEW DESIGNS FOR 2023 SEASON'

The Outdoor Revolution furniture range covers everything that will need for your caravanning holiday with many new models & innovative additions for the 2023 season.

A comprehensive range of popular best selling premium chairs in coordinating fabrics to complement your Outdoor Revolution caravan or motorhome awning, covering compact tub style models with XL options in a choice of modern fabrics & colours, high back XL camping chairs; premium reclining fold flat, lounge & bed lounge models in choices of fabrics including padded polyester, textile & fast drying padded air mesh, plus new innovative models for 2023 including a padded 2 seat tub style model.

Our range of premium camping tables for 2023 includes current best selling models with various size & compact folding options for dining, including heat proof & weather proof alu top models for dining or cooking, premium lightweight weather proof height adjustable models plus a new exciting range of premium bamboo top models.

Finally our wide range of value and premium utility & storage furniture covering folding wardrobe storage in various sizes and volume capacity, plus a range of kitchen utility, storage & cook stand units with new models for 2023.

Chairs



Tables



Utility storage



FOR DETAILS OF THE FULL RANGE OF 2023 OUTDOOR REVOLUTION SHELTERS & WINDBREAKS CHECK OUT:
WWW.OUTDOOR-REVOLUTION.COM



**OUTDOOR
REVOLUTION** 
WWW.OUTDOOR-REVOLUTION.COM

...Bringing the outdoors to everyone

ESPRIT PRO X AIR AWNINGS - conceived with a passion for excellence

**'THE ULTIMATE IN LUXURY
CARAVAN & MOTORHOME
AIR AWNINGS'**

OXYGEN
AIR FRAME

The all new Esprit Pro X awning collection is a premium range of 2 caravan air awnings and 1 motorhome driveway awning model.

Style & luxury are just two words for describing the all new Outdoor Revolution Esprit Pro X premium awning range. A collection of two caravan awning models & one motorhome driveway awning model. Complemented with an optional cross compatible side extension & side conservatory style annexe with sleeping inner, this stunning new awning range is set to take caravanning & motorhome touring by storm.

Based on the newly developed single inflation connective lock off air frame system & using the most up date cutting edge technology which enables sections of the air frame to be connected and then isolated with air lock off valves; this ground breaking system offers total ease of inflation & deflation with total peace of mind.

Constructed in our luxury 600HD premium awning fabric for durability & complete weather protection, the all new Esprit Pro X awning range ticks all the boxes for any discerning camper who simply demands nothing but the best

...for those who demand the best



Esprit Pro X Annexe 390 shown with optional extension & annexe



ESPRIT PRO X 330

'Premium caravan awning with lock off air system - total peace of mind'

Based on the larger 390 model, the **Esprit Pro X 330** offers all the same features as its larger sibling in a more compact size for slightly smaller caravans with awning rails up to 330cm. Featuring a full zip back front door with left hand side mesh panel for ventilation whilst keeping out insects. If additional space is required, an optional left hand side extension or left and right hand fitting annexe can be added, creating additional rooms for dining etc, with the annexe featuring its own included 2 berth sleeping inner tent.

Key Features

- Pro 600HD high density all weather premium fabric
- Hydrostatic head 6000mm
- 3 YEAR WARRANTY on the Air Frame System (T's & C's apply)
- Oxygen Air Frame with Dynamic Speed Valve system
- Single point air lock off connective tube system
- Integral front canopy
- Front left and right full zip across door with zip back left Phoenix mesh panel
- Zip out left and right side doors with zip back Phoenix mesh panels
- Zip on left side extension option plus left or right annexe with inner option
- Fracture* design (new) zip up blind style curtain system
- Tinted anti glare PVC windows
- Ground Anchor Webbing secure guying system
- Adjustable webbing pegging system
- Includes pump, draught skirt, peg set, storm straps and carry bag

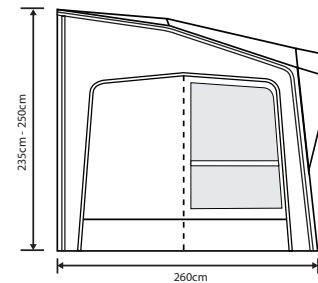
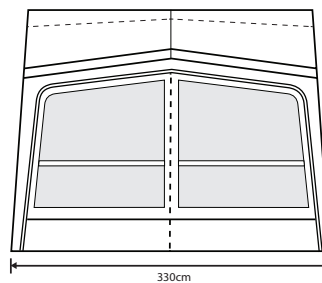

Esprit Pro X 330

Height Range 235cm - 250cm

Total Weight 30kg
Pack Size 87x53x46
Footprint 260 x 330cm

ESPRIT PRO X 390

'Our flagship premium single point inflation caravan air awning'

The **Esprit Pro X 390** luxury family caravan awning is constructed from our acclaimed luxury 600HD high density all weather premium awning fabric in stunning graphite and platinum. Built on our latest state of the art interconnected tube system, incorporating a series of air valves and connection links which join the whole air frame together whilst also enabling individual sections to be isolated, providing total peace of mind. Featuring a full zip back front door with left hand side mesh panel for ventilation whilst keeping out insects. If additional space is required, an optional left hand side extension or left and right hand fitting annexe can be added, creating additional rooms for dining etc, with the annexe featuring its own included 2 berth sleeping inner tent.



Key Features

- Pro 600HD high density all weather premium fabric
- Hydrostatic head 6000mm
- 3 YEAR WARRANTY on the Air Frame System (T's & C's apply)
- Oxygen Air Frame with Dynamic Speed Valve system
- Single point air lock off connective tube system
- Integral front canopy
- Front left and right full zip across door with zip back left Phoenix mesh panel
- Zip out left and right side doors with zip back Phoenix mesh panels
- Zip on left side extension option plus left or right annexe with inner option
- Fracture* design (new) zip up blind style curtain system
- Tinted anti glare PVC windows
- Ground Anchor Webbing secure guying system
- Adjustable webbing pegging system
- Includes pump, draught skirt, peg set, storm straps and carry bag

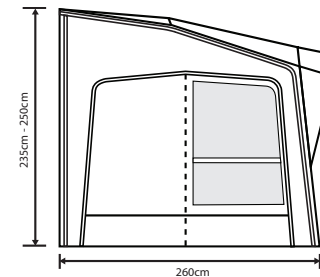
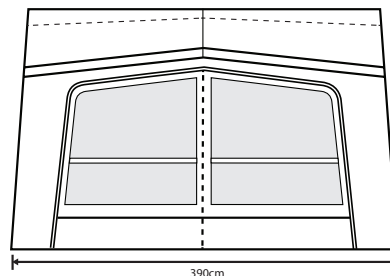

Esprit Pro X 390

Height Range 250cm - 265cm

Total Weight 32.5kg
Pack Size 87x53x48
Footprint 260 x 390cm



ESPRIT PRO X 350M

'Premium driveaway motorhome awning with lock off air system'

The all new **Esprit Pro X 350M** driveaway motorhome awning, constructed from our acclaimed luxury 600HD high density all weather premium awning fabric in stunning graphite and platinum. Built on our latest state of the art interconnected tube system, incorporating a series of lock off air valves and connection links which join the whole air frame together whilst also enabling individual sections to be isolated, providing total peace of mind. Featuring an adjustable height driveaway rear cowl section, full zip back front door with left hand side mesh panel for ventilation. An optional left hand side extension can be added, creating another separate room for dining etc. A further multi handed annexe can be added, providing further living/storage space and comes complete with its own 2 berth sleeping inner tent.

Key Features

- Pro 600HD high density all weather premium fabric
- Hydrostatic head 6000mm
- 3 YEAR WARRANTY on the Air Frame System (T's & C's apply)
- Oxygen Air Frame with Dynamic Speed & Intelligent Frame relief valve system
- Single point air lock off connective tube system
- Rear driveaway cowl section with 4mm & 6mm twin piping connection beading
- Integral front canopy
- Front left and right full zip across door with zip back left Phoenix mesh panel
- Zip out left and right side doors with zip back Phoenix mesh panels
- Zip on left side extension option plus left or right annexe with inner option
- Fracture* design (new) zip up blind style curtain system
- Tinted anti glare PVC windows
- Ground Anchor Webbing secure guying system
- Adjustable webbing pegging system
- Includes pump, draught skirt, peg set, storm straps and carry bag



Shown with Esprit Pro X Annexe

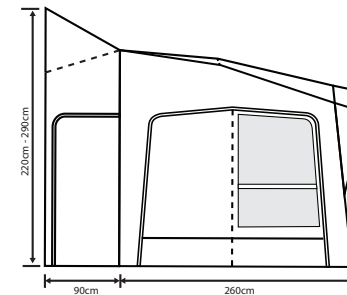
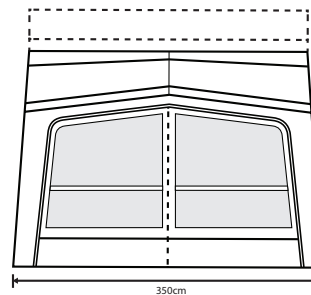

Esprit Pro X 350 M

Height Range 220cm - 290cm

Total Weight 39kg
Pack Size 87x55x51
Footprint 260 x 350cm (+90cm cowl)

ESPRIT PRO X EXTENSION

‘Premium awning extension with lock off air connection system’

The **Esprit Pro X Extension** is a multifunctional extension, designed as a left hand fit and compatible with all new 2023 Esprit Pro X caravan awning models, including the new Esprit Pro X 350M motorhome driveaway model.

Featuring a full zip back front door, side window with upper mesh ventilation & rear zip back door, enabling rear entry to the extension and access to the caravan side locker box.

Incorporating the same interconnected lock off air system as the main awning, the extension is both easy to attach and inflate whilst offering the ability to isolate tube sections to give total peace of mind. With a footprint of 255cm x 275cm, the Esprit Pro X Extension provides fantastic extra usable space to your main awning without the need for extra caravan rail length.



Key Features

- Pro 600HD high density all weather premium fabric
- Hydrostatic head 6000mm
- 3 YEAR WARRANTY on the Air Frame System (T's & C's apply)
- Oxygen Air Frame with Dynamic Speed Valve system
- Single point air lock off connective tube system
- Zip back rear door to access caravan locker box
- Front full zip across door
- Side window with Phoenix mesh upper ventilation
- Fracture* design (new) zip up blind style curtain system
- Tinted anti glare PVC windows
- Ground Anchor Webbing secure guying system
- Adjustable webbing pegging system
- Compatible with all Esprit Pro X models
- Includes, peg set, storm straps and carry bag

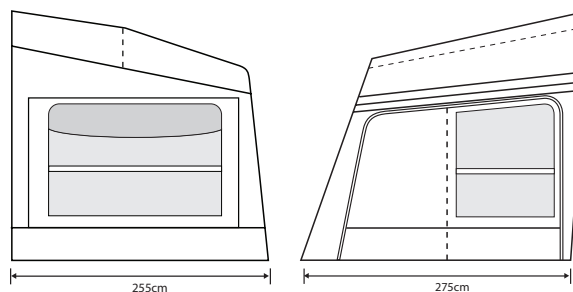

Esprit Pro X Extension

Total Weight 17.8kg
Pack Size 75x40x32
Footprint 275 x 255cm



ESPRIT PRO X ANNEXE

'Premium awning living air annexe with 2 berth sleeping inner tent'

The **Esprit Pro X Annexe** is a multifunctional living annexe, designed as a left and right hand fit, compatible with all new 2023 Esprit Pro X caravan awning models, including the new Esprit Pro X 350M motorhome driveaway model. The annexe is easy to attach via a heavy duty tooth count zip and is easy to erect by the air frame inflation system which features our acclaimed DSV inflation valve. Featuring a front and rear fully zip back windowed door which enables a mirrored left and right hand fit to your Esprit Pro X awning. A generous footprint of 225cm x 240cm with a stand up central height of 190cm, enables the annexe to be used for dining as well as sleeping and storage. An included 2 berth sleeping inner tent completes the package for this very versatile annexe addition to your Esprit Pro X awning.

Key Features

- Pro 600HD high density all weather premium fabric
- Hydrostatic head 6000mm
- 3 YEAR WARRANTY on the Air Frame System (T's & C's apply)
- Oxygen Air Frame with Dynamic Speed valve system
- Universal left hand and right hand fitting
- Zip across front and rear door for left and right hand fitting
- Fracture* design (new) zip up blind style curtain system
- Tinted anti glare PVC windows
- Ground Anchor Webbing secure guying system
- Adjustable webbing pegging system
- Compatible with all Esprit Pro X models
- Includes, 2 berth inner tent, peg set and carry bag

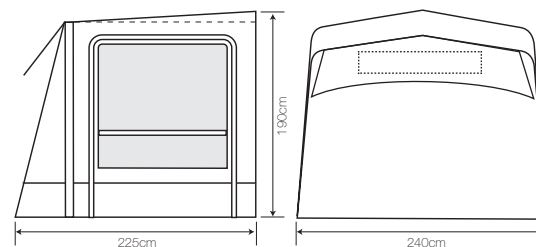

Esprit Pro X Annexe

Total Weight 12.5kg
Pack Size 73x37x30
Footprint 225 x 240cm

CARAVAN WINDBREAKS... AIR, POLED & POP-UP

‘WINDBREAKS DESIGNED TO COORDINATE PERFECTLY & COMPLEMENT YOUR CARAVAN AWNING’

The Outdoor Revolution windbreak range with specific models designed to coordinate & complement your caravan awning, including inflatable air models, Pronto pop-up quick erect models & conventional pole models with end beading designed to connect to your caravan side awning rail.

Our premium Oxygen Pro 3 panel air windbreak is constructed from the same premium awning fabric as our Eclipse & new Esprit Pro X models, designed to perfectly complement & seamlessly integrate with your caravan or motorhome awning. Additional panels can be added to extend the length of the air windbreak if required.

The Pronto Pro 3 panel windbreak, again constructed from the same premium awning fabric as the Eclipse & new Esprit Pro X models, is a quick erect pop-up design which can be set up & connected to your caravan side awning rail in a matter of a couple of minutes. Multiple units can be connected together to achieve any desired length by connecting together with a simple figure of ‘8’ connection strip.

Air Windbreaks



Pronto Pop-UP Windbreaks



Pole Windbreaks



**FOR DETAILS OF THE FULL RANGE OF 2023 OUTDOOR REVOLUTION SHELTERS & WINDBREAKS CHECK OUT:
WWW.OUTDOOR-REVOLUTION.COM**



OUTDOOR
REVOLUTION 
WWW.OUTDOOR-REVOLUTION.COM

...Bringing the outdoors to everyone

2 BERTH CLIP IN INNER TENT for driveaways, awnings & tents

Outdoor Revolution's **Two Berth Inner Tent** is the perfect optional extra bedroom for caravan awnings, driveaways & family tents, increasing the sleeping capacity by two. We have given this bedroom a universal fit across our latest collections, making it compatible with an extensive selection of models. The inner tent can be effortlessly clipped in/out of the corresponding coloured clips. The darkened fabric keeps conditions comfortably dim, creating a more relaxing sleeping atmosphere.



2 BERTH CLIP IN INNER TENT

Material: Polyester
Size: 205 x 130cm (floor area)
Pack Size: 60 x 40 x 33cm
Weight: 1.6kg



ADJUSTABLE REAR PAD POLES for caravan awnings

Outdoor Revolution's **Adjustable Rear Pad Poles** are designed to fit against the rear pad of your caravan / motorhome awning to maintain a draught proof & more watertight fit of your awning against the side of your caravan / motorhome. Made from steel sections with a tough powder coated finish, these poles are fitted with a robust adjustable clamp to ensure the perfect fit against your caravan / motorhome. Sold in pairs in a handy draw string polyester storage bag.



ADJUSTABLE REAR PAD POLES

Material: Steel
Size: 215-270cm
Pack Length: 115cm
Weight: 1.83kg

UNIVERSAL ANNEXE for traditional poled awnings

The newly updated Universal Annexe is the perfect retro fitting sleeping annexe solution & compatible with most traditional rigid poled awnings. Made from 280HD (4000HH) all weather lightweight fabric with steel pole, the annexe is connected to the side door opening by means of an adjustable webbing strap connection system for a water tight fit. The annexe comes complete with a 2 berth breathable sleeping inner tent, fitted with a waterproof groundsheet, draught proof mudwall & comes complete with steel ground pegs & carry/storage bag.



Designed to fit traditional rigid poled awnings



Complete with 2 berth sleeping inner tent



UNIVERSAL ANNEXE

Height: 110cm
Footprint: 150 x 210cm
Pack Size: 66 x 19 x 19cm
Weight: 7.12kg

AIR POD INNER TENT for awnings, driveways & tents

Outdoor Revolution's two berth Air Pod Inner Tent is an innovative free standing inflatable 2 berth sleeping inner tent, designed to be quickly inflated and positioned in any space inside a tent, awning or driveway to provide instant additional sleeping accommodation for up to 2 people. The inflatable free standing design allows the Air Pod to be moved around to any desired position and then quickly deflated and packed away during the daytime when not in use to free up living space. Updated with darkened fabric to block out more light for a better nights sleep

TYPHOON - AIR TUBE INFLATOR DC 12v (16psi)

The Outdoor Revolution **Typhoon Air Tube Inflator** air pump is a high pressure DC 12V air pump, designed for the inflation of tent, awning & driveway air tubes as well as being suitable for high pressure inflatables such as SUP's. With a large air volume output of up to 120L/min the Typhoon makes easy work of inflating anything with a large volume high pressure air capacity. This powerful pump can achieve a maximum air pressure of up to 16PSI and can be set at the desired pressure for automatic cut off to prevent over inflation.

RECHARGEABLE SUP / AIR TUBE INFLATOR - (16psi)

The Outdoor Revolution **Rechargeable SUP / Air Tube Inflator** air pump is a high pressure rechargeable DC 12V air pump, designed for the inflation of tent, awning & driveway air tubes as well as being suitable for high pressure inflatables such as SUP's. With an air volume output of up to 70L/min the pump makes easy work of inflating anything with a large volume high pressure air capacity. A maximum air pressure of up to 16PSI and can be set at the desired pressure for automatic cut off to prevent over inflation. This rechargeable pump is highly portable with its internal power source.



AIR POD INNER TENT

Material: Polyester
Size: 210 x 135cm (floor area)
Pack Size: 58 x 19 x 15cm
Weight: 0.9kg



TYPHOON AIR TUBE INFLATOR

Power Source: DC 12V
Max Pressure: 16PSI
Air Flow: 120L / min
Includes: adaptors & hose



RECHARGEABLE SUP AIR INFLATOR

Power Source: DC 12V +
internal rechargeable battery
Max Pressure: 16PSI
Air Flow: 70L / min
Includes: adaptors & hose



SLEEPING BAGS & SELF INFLATING AIR MATTRESSES

'SELF INFLATING AIR MATTRESSES & SLEEPING BAGS TO KEEP YOU COSY WARM & COMFORTABLE'

Outdoor Revolution offer a comprehensive range of sleeping bags and self inflating air mattresses to provide comfort & warmth for your awning annexe sleeping arrangement.

Our 'Camp Star', 'Sun Star' & premium 'Star Fall' ranges of sleeping bags & Camping Duvets are available in Single, Midi, Double & King sizes in 200g, 300g, & 400g hollow fibre filling weights, providing up to 3 seasons of warmth & comfort. Available in a range of modern colours with contrast coordinating liners in Ensign Blue, Adriatic Blue, Blue Coral, After Dark & Monument Grey; packed in stuff sacks with compression straps with premium models packed in square zipped fabric carry bags.

A comprehensive range of premium self inflating 'Camp Star' & 'Star Fall' mattresses in 75, 120 & 150 thickness' in Single, Midi & Double widths are constructed in luxury feel Polyester Pongee & Peach soft touch fabrics which coordinate and complement our range of sleeping bags, providing a luxuriously comfortable nights sleep.

CAMP STAR



CAMP STAR



CAMP STAR



SUN STAR



STAR FALL



STAR FALL



SUN STAR



**CHECK OUT
WWW.OUTDOOR-REVOLUTION.COM
FOR DETAILS OF THE FULL RANGE
OF 2023 OUTDOOR REVOLUTION
SELF INFLATING MATTRESSES
& SLEEPING BAGS**

**OUTDOOR
REVOLUTION** 
WWW.OUTDOOR-REVOLUTION.COM

...Bringing the outdoors to everyone





**OUTDOOR
REVOLUTION**
WWW.OUTDOOR-REVOLUTION.COM



***LIFETIME GUARANTEE** - Terms & Conditions Apply. See website for details.

Please note: In the interest of continuous product development & improvements by Outdoor Revolution; some products & specifications, including dimensions & colour variations, may differ slightly from the images, diagrams & information given within this brochure. Dimensions & weights are approximate & are intended as a guide only at the time of going to press.

Please check our website for the most up to date product information

Web: www.outdoor-revolution.com / www.blue-diamond-products.co.uk



...Bringing the outdoors to everyone